

MAXIMULCH

Return the warranty certificate within 15 days together with a copy of the invoice (*without these documents the warranty procedure cannot be implemented*).



Original Manual

FOREWORD

This manual is provided with your machine to enable you to make optimum use of your equipment, in particular under safe working conditions.

All owners are reminded that the manual is **an essential accessory** which must remain with the machine at all times, and that in the event of resale, article 1615 of the Civil Code requires that as such it **must be handed over** to the new owner.

You are also reminded that as the manual is essential to the machine, all owners must undertake to **leave it physically** available with the machine for all users to consult.

Original Manual: http://bit.ly/manuels_agrisem



WARRANTY CERTIFICATE NUMBER



TO BE RETURNED ON RECEPTION OF THE MACHINE

Dealer
Name
Address
Tel.

Purchaser
Name
Address
Tel.

Type of machine:	
Working width:	
Machine serial number:	
Customer and user delivery date:	
Make, model and power of the tractor used:	
Type of soil, % clay:	
Utilised agricultural area belonging to the farm:	

Signed in:.....
On.....

Signature and stamp of the purchaser

Signature and stamp of the dealer

We acknowledge that we have read the whole of the user manual and the warranty clauses, to which we adhere.

AGRISEM INTERNATIONAL - 535 Rue Pierre Levasseur CS 60263 – 44158 ANCENIS CEDEX
Tel.: +33 (0)2 51 14 14 40 – Fax: +33 (0)2 40 96 32 36

DECLARATION OF COMPLIANCE WITH THE "MACHINERY" DIRECTIVE



The manufacturer referred to above certifies that the new equipment described below:

MAXIMULCH

Complies with the provisions of the amended "Machinery" directive (Directive 2006/42/CE) and with the applicable national legislation.

Ancenis,

21 May 2013

Michal Guzowski
Chief Executive Officer

Identification of the machine

On receipt of the machine, please enter the corresponding information below:

Type of machine:

Serial number:

Year of manufacture:

Date of first use:

Accessories:

Name of the Dealer:

Address

.....

.....

Telephone number:

AGRISEM INTERNATIONAL
535 Rue Pierre Levasseur CS 60263 – 44158 ANCENIS CEDEX
Tel.: +33 (0)2 51 14 14 40 – Fax: +33 (0)2 40 96 32 36
Email: agrisem@agrisem.com

CONTENTS

- 1. WARRANTY CONDITIONS 11
 - 1.1. EXCLUSIVE LIABILITY CLAUSE..... 14
 - 1.2. COMPLIANT USE OF THE MACHINE 15
 - 1.3. SAFETY INSTRUCTIONS..... 16
 - 1.3.1. Safety instructions 16
 - 1.3.1.1. Introduction 16
 - 1.3.1.2. Instructions to be followed before using the machine 17
 - 1.3.1.3. Instructions to be followed for hitching and unhitching..... 18
 - 1.3.1.4. Instructions to be followed before using the machine 19
 - 1.3.1.5. Instructions to be followed before carrying out any operations on the machine 21
 - 1.3.1.6. Instructions regarding installation 22
 - 1.3.1.7. Instructions regarding the hydraulic system 23
 - 1.3.1.8. Instructions relating to the braking system 23
 - 1.3.1.9. Instructions specific to AGRISEM seeders..... 24
 - 1.3.1.10. Instructions relating to safety systems with spring assemblies 25
 - 1.3.1.11. Instructions relating to transmission shafts with universal joints 25
 - 1.3.1.12. Instructions relating to loading and transport 25
 - 1.3.1.13. The user's workstation..... 25
 - 1.3.1.14. Noise data..... 25
 - 1.3.2. Safety symbols on the machine..... 26

- 2. TECHNICAL INSTRUCTIONS 27
- 2.1. SETTINGS AND USE..... 27
 - 2.1.1. Technical characteristics 27
 - 2.1.2. Hitching and unhitching the Maximulch 28
 - 2.1.2.1. Tractor-mounted machine 29
 - 2.1.2.2. Trailed machine 29
 - 2.1.3. Folding - Unfolding..... 30
 - 2.1.4. Starting up the MOUNTED MAXIMULCH 32
 - 2.1.5. Starting up the TRAILED MAXIMULCH 34
 - 2.1.6. Starting up the MAXIMULCH Series 6 38
 - 2.1.7. Recommendations for use:..... 40
 - 2.1.8. Operating recommendations: 41
- 2.2. SERVICING - MAINTENANCE 41
 - 2.2.1. Servicing frequency 41
 - 2.2.2. Storage 42
 - 2.2.3. Lubrication 42
 - 2.2.4. Maintenance 43
 - 2.2.5. Lighting system 45

The warranty certificate MUST be returned within 15 days of delivery of the machine to the final user.

You have just taken ownership of your AGRISEM machine. It has been designed to give complete satisfaction.

The equipment has been carefully designed using the latest technological solutions to reduce usage costs.

However, for the best and most profitable use of your AGRISEM machine, please read this manual carefully before starting it up and strictly follow the instructions. In particular, follow the instructions for adjusting and servicing the machine, as well as the safety precautions, very carefully.

Please contact our distributor for any information or advice.

The instructions in this user manual must be read and applied by any persons who will be carrying out work on or with the machine, in particular:

- Use of the machine (including preparation, repairs required during work and maintenance).
- Maintenance (servicing and inspection).
- Transport.

AGRISEM INTERNATIONAL cannot be held liable for personal injury or damage to equipment and malfunctions resulting from failure to comply with the instructions given by the manufacturer in this manual.

This user manual is an integral part of the machine and must always be kept with the machine, especially in the event of resale.

AGRISEM INTERNATIONAL is constantly seeking to improve its products and reserves the right to modify or improve its products with no obligation to apply these modifications or improvements to products already on the market.

The instructions in this manual are not exhaustive and cannot cover all eventualities. The user must comply with the applicable legislation, in particular with regard to safety, ensure that the rules of safety and caution dictated by the situation are applied, use common sense and adapt the use of the machine to the circumstances.

It is the Purchaser's responsibility to check that the AGRISEM machine complies with the legislation and regulations applicable to its final destination.

1. WARRANTY CONDITIONS

The warranty conditions applicable to machines fitted exclusively with genuine spare parts from AGRISEM INTERNATIONAL are as follows:

➤ DURATION

- If a defect is observed on a structural part within a period of **12 months** as from the date of delivery of the machine, and if this defect is due to faulty raw materials, or its manufacture at the factory. The parts alleged to be faulty must be returned to the Company's address for an expert inspection.

The following shall be considered to constitute proof of the date of delivery of the equipment:

- the date of the delivery slip and the purchaser's invoice.
- the return of the warranty certificate within 15 days (with the dealer's and purchaser's stamp and signature) following delivery of the equipment.

➤ MACHINES AND PARTS CONCERNED

- For the purposes of this warranty, the term "Machine" is exclusively used to designate machines and parts manufactured by AGRISEM INTERNATIONAL. (It does not include external components, in particular tyres, hydraulic hoses, etc. even though these parts are also supplied by the Company)

- **The warranty is void if any modifications have been made to the machine without the formal agreement of AGRISEM INTERNATIONAL or if parts other than those manufactured by the Company have been fitted (e.g. counterfeit wear parts).**

➤ EXTENT OF THE WARRANTY

- The warranty is limited to the reimbursement or repair of parts recognised as faulty with regard to their raw materials or machining, in our factories by our Technical Departments.
- Any costs linked to the dismantling and replacement of the faulty part are not covered by the warranty. The cost of transporting machines or machine parts to the place of repair and their return to their owner is not covered either.
- Wear parts are not covered by the warranty.

➤ PRECONDITIONS

The machine must be maintained and used in accordance with the instructions in this User Manual.

All of the safety measures described in the User Manual and in the manuals of any additional equipment must be complied with.

All of the protection and safety devices and hazardous parts (e.g. shock absorbers) must be regularly inspected and replaced if necessary.

The warranty is only valid if the customer has met the contract's general obligations, in particular the payment conditions.

➤ **WARRANTY EXCLUSIONS**

The warranty does not of course apply to:

- Faults due to normal wear, incorrect use, lack of maintenance, inadequate monitoring or negligence.
- If the machine is damaged by an accident or develops a fault due to being used for purposes other than those specified by AGRISEM.
- In the event of non-compliant use of the machine. Please consult chapter 3 with regard to this point: Compliant use of the machine.
- If the manufacturer's instructions and requirements given in this manual are not complied with, particularly those regarding safety, assembly, use, operation and servicing.
- In the event of improper handling on the part of the user.
- Causes due to the presence of foreign bodies.
- In the event of damage due to the machine being combined with other machines or instruments without the prior written agreement of AGRISEM, and/or without complying with the instructions given by the manufacturers of the tractor and other instruments or machines.
- If the machine is used with protection and safety devices that are incorrectly fitted or not working.
- If the machine has been modified without prior written permission from AGRISEM, or if spare parts, accessories or equipment have been fitted to the machine which were not recommended by AGRISEM.
- In the event of non-compliant repair.
- If faults are due to the machine being immobilised.
- In the event of damage during transport or handling by a carrier. It is the recipient's responsibility to lodge the necessary complaints with the carrier.
- The adverse consequences of the machine being immobilised due to a fault or incident on the machine are not covered by the warranty.
- Personal injury to the owner or a third party and the indirect consequences resulting from this are not covered by the warranty.

Moreover, AGRISEM INTERNATIONAL shall not be liable for the payment of compensation for any reason whatsoever in the event of the loss of crops or any damage whatsoever due to a fault, hidden defect or machine breakdown.

The purchaser is always responsible for the choice of product and the suitability of the machine for the result that he hopes to obtain. He is responsible for its correct use in line with professional practice and the regulations.

Under no circumstances will AGRISEM INTERNATIONAL have any obligation with regard to the final result.

➤ **LIMITATIONS AND LIABILITY**

- The warranty cannot be assigned or transferred to any other person without the prior written permission of AGRISEM INTERNATIONAL.
- Under no circumstances do those selling our machines have the right or power to make any decision whatsoever, either express or tacit, in the Company's name.
- The technical assistance given by the Company or its representatives with the repairing or operation of equipment does not make it liable for any costs and in no way alters or leads to the waiving of the conditions of this warranty.

➤ **WARRANTY ENFORCEMENT PROCEDURE: TO BE STRICTLY ADHERED TO BY THE DISTRIBUTOR AND BY THE PURCHASER**

The warranty's enforcement is subject to strict compliance by the dealer and the user with the following requirements:

A) RETURNING BY THE DEALER OF THE WARRANTY CERTIFICATE DULY COMPLETED AND SIGNED BY THE DEALER AND THE PURCHASER.

B) Claims must be made without fail using an AGRISEM INTERNATIONAL "WARRANTY CLAIM FORM" (see appendix) and sent by registered letter with acknowledgement of receipt by the dealer to the company's technical department within 10 days of the incident. This form must be completed legibly by the dealer and must include the following information:

- Name and address of the dealer, code No.,
 - Name and address of the purchaser,
 - Type of machine,
 - Working width,
 - Machine serial number,
 - Date of delivery to the purchaser,
 - Date of breakdown,
 - **Precise references of the parts replaced, No. and date of invoice,**
 - **Make and model of the tractor used,**
 - Detailed description and alleged cause of the incident.
 - Surface worked with the Disc-O-Mulch,
 - Utilised agricultural land belonging to the farm,
 - Type of soil in terms of % clay,
 - Proof of wear part invoice
- Stones yes no
- Parts replaced yes no (send the photocopy of the invoice)

C) Allegedly faulty parts are to be returned by the dealer to the Company's address for an expert inspection, together with the copy of the warranty claim form provided for this purpose. The dealer must order the faulty part from the spare parts department. Any transport costs incurred by the returning of said parts are payable by the sender.

D) The final decision regarding payment under the terms of the warranty shall be made by the company's technical or general management. Whatever the reason for the warranty claim, this decision is final and irrevocable and the purchaser undertakes to accept this decision both with regard to the fault and the replacement of the part or parts.
Under no circumstances are the company's salesmen authorised to make such a decision, which would be void.

NOTE: In the event of refusal, the part remains at the customer's disposal for eight days. After this time it will be scrapped with no appeal possible.

Under no circumstances do those selling our machines have the right or power to make any decision whatsoever, either express or tacit, in the Company's name.

➤ 5-YEAR WARRANTY AGREEMENT

If the customer subscribes to the 5-year warranty, please see this agreement for the terms and conditions of the warranty's enforcement.

1.1. EXCLUSIVE LIABILITY CLAUSE

AGRISEM INTERNATIONAL denies any liability for damage (and any indirect consequences linked to it) resulting from one or more of the following causes:

- Non-compliant use of the machine.
- Failure to follow the manufacturer's instructions or those given in this manual, particularly those regarding safety, assembly, start-up, use, operation and servicing.
- Unsuitable assembly, start-up, use and maintenance of the machine.
- Use of the machine with faulty protection and safety devices or safety and protection devices that are incorrectly installed or not working.
- Combining of the machine with other instruments or machines without the written agreement of AGRISEM and/or without complying with the instructions given by the manufacturers of the tractor and other instruments or machines.
- Modifications made to the machine without the written permission of AGRISEM.
- Fitting of spare parts, accessories or equipment on the machine which are not genuine or which have not been recommended by AGRISEM.
- Failure to monitor the wear parts on the machine.
- Use of the machine other than for the purposes specified by the manufacturer.
- Non-compliant repair and maintenance.
- Catastrophes resulting from the presence of foreign bodies, unforeseeable circumstances and cases of force majeure.

Moreover, AGRISEM INTERNATIONAL cannot be held liable for injury to the owner or a third party or for the indirect consequences of such an injury, whether or not it results from a fault. You are reminded that a safe distance of 50 metres must be maintained around the machine.

Any claim for compensation for damage that did not occur directly on the machine is excluded.

AGRISEM INTERNATIONAL cannot be held liable for damage caused by driving or use errors.

AGRISEM INTERNATIONAL cannot be held liable for compensation for the consequences of the instrument's immobilisation due to a fault or an incident on the machine.

1.2. COMPLIANT USE OF THE MACHINE

AGRISEM INTERNATIONAL products must only be used for the work for which they were designed:

Work on arable land under normal conditions

In the event of damage linked to the use of the machine other than for the purposes specified by the manufacturer, the manufacturer shall be entirely released from liability.

Only use the machine in good technical condition, in accordance with the purpose for which it was designed and in full knowledge of the risks.

Compliant use of the machine also involves:

- Compliance with the instructions for use, servicing and maintenance issued by the manufacturer
- Compliance with all of the instructions in this manual, particularly including the safety instructions
- The exclusive use of genuine spare parts, accessories and equipment or those recommended by the manufacturer.

AGRISEM machines must not be combined with other machines or instruments without prior written permission from AGRISEM INTERNATIONAL.

For any combinations, the user must also comply with the instructions given by the tractor manufacturer.

AGRISEM machines must only be used, serviced and repaired by competent persons who are familiar with the machine's features and operating procedures. These persons must be informed of the dangers to which they may be exposed.

The user is required to strictly comply with the current legislation with regard to:

- Accident prevention
- Safety at work (labour code)
- Driving on the public highway (Highway code)

He is required to observe the warnings affixed to the machine. Any modifications made to the machine by the user or any other person without the prior written permission of the manufacturer releases the latter from any liability for the damage which may result.

Damage resulting from non-compliant use of the machine:

- Is entirely the user's responsibility,
- May under no circumstances be assumed by AGRISEM INTERNATIONAL

1.3. SAFETY INSTRUCTIONS

1.3.1. Safety instructions

1.3.1.1. Introduction

Most accidents which occur during work, maintenance or travel from one place to another are due to a failure to observe the most basic safety rules. It is therefore essential for anyone likely to be working with this machine to adhere to the basic rules listed below and to the safety instructions displayed on the stickers affixed to the machine.

This machine has been designed for a specific task. It must always be in good working order and must only be repaired using genuine AGRISEM INTERNATIONAL spare parts.

This machine must only be used, maintained and repaired by competent persons who are familiar with its features and its operating procedures and who are aware of the safety rules for accident prevention and the dangers to which they may be exposed.

This machine must only be used in accordance with its purpose and in a condition that does not present any safety risks. Any malfunctions likely to be detrimental to safety must be corrected immediately.

The user is required to strictly adhere to the safety instructions in this manual and the stickers affixed to the machine.

The user is also required to strictly comply with the current legislation with regard to accident prevention, safety at work (labour code), occupational medicine and highway legislation.

Before using the machine for the first time, read all of the safety instructions in this user manual carefully and familiarise yourself with the controls.

The machine must never be entrusted to a person who is not trained to use it.

Liability and warranty:

In addition to the other cases mentioned in this manual, the manufacturer denies any liability for any injury or damage to equipment resulting from one or more of the following causes:

- Failure to follow the manufacturer's instructions or those given in this manual, particularly those regarding safety, assembly, start-up, use, operation and servicing.
- Non-compliant use of the machine.
- Unsuitable assembly, start-up, use and maintenance of the machine.
- Use of the machine with faulty protection and safety devices or safety and protection devices that are incorrectly installed or not working.
- Combining of the machine with other instruments or machines without the written agreement of AGRISEM and/or without complying with the instructions given by the manufacturers of the tractor and other instruments or machines.
- Modifications made to the machine without the written permission of AGRISEM.
- Fitting of spare parts, accessories or equipment on the machine which are not genuine or which have not been recommended by AGRISEM.
- Failure to monitor the wear parts on the machine.
- Use of the machine other than for the purposes specified by the manufacturer.
- Non-compliant repair and maintenance.
- Catastrophes resulting from the presence of foreign bodies, unforeseeable circumstances and cases of force majeure.

Similarly, in addition to the other cases mentioned in this manual, any claim under the warranty linked to damage resulting from one or more of the above-mentioned causes is excluded.

1.3.1.2. Instructions to be followed before using the machine

Wear close-fitting clothes. Loose clothing may become caught in moving parts.

Wear individual protective equipment corresponding to the work you are planning to do (gloves, shoes, goggles, helmet, ear protection, etc.).

Be aware that tillage equipment, even if not very wide, has very sharp parts (blades, shares, disks, etc.) which can cause serious injury in the event of an accident.

Whenever the machine is used, check the area around the machine beforehand (presence of children). Ensure you have sufficient visibility.

Before any work, ensure that the tractor is sufficiently weighted at the front to avoid any risk of the front lifting. If not, add weights to the front of the tractor.

Check that screws, nuts and bolts are correctly tightened whenever you use the machine. Tighten if necessary. Also check the condition of the tools and their fastening elements in accordance with the instructions in this manual.

No-one must be within 50 metres of the machine when it is being folded and unfolded.

Check that the machine is correctly hitched.

Always install the pins and locking systems.

Check that the machine meets personal safety requirements.

Whenever you use the machine, check that the safety and protection devices are in place and working. Replace any worn or damaged protectors immediately.

Move any people or animals likely to be in the area where the machine is being manoeuvred or used. A 50-metre safety zone must be kept clear around the machine.

Go around the machine looking for any external damage and checking the condition of the protection devices.

Only persons authorised by the owner of the machine and who have been trained and instructed are allowed to work on and with this machine. The operator is responsible towards third parties when he is working on and with the machine.

The owner of the machine must:

- Provide the operator with the user manual.
- Ensure that the operator has read it and understands it.
- Ensure that the operator knows the basic instructions regarding safety at work and accident prevention.
-

1.3.1.3. *Instructions to be followed for hitching and unhitching*

Pay attention to the various possibilities permitted for the connecting of the tractor's coupling equipment to that of the machine.

Only combine equipment that is compatible (machine and tractor).

- **Check that the tractor has the characteristics necessary to hitch the machine.**

WARNING:

Non-compliant implementation may result in a risk of the tractor breaking during operation, being insufficiently stable when loaded and having insufficient manoeuvrability and braking power.

Check that the tractor meets the necessary requirements before installing or hitching the machine.

The machine must only be mounted on or hitched to a tractor if it meets the necessary requirements.

Perform a braking test to check that the tractor can provide the regulatory deceleration power even with the machine mounted or hitched.

The requirements relating to the tractor include:

- The total authorised weight
- The authorised axle loads
- The authorised vertical load on the tractor coupling point
- The permissible load capacities of the tyres mounted on the tractor
- Sufficient authorised load on the coupling point

You will find this information on the data plate or in the vehicle's registration papers and in the tractor user manual.

The front axle must support at least 20% of the tractor's empty weight at all times.

- Calculation of the real values of the total tractor weight, tractor axle load and the load capacity of the tyres, and of the minimum ballast required:

The total authorised weight of the tractor indicated in the vehicle's registration papers must be greater than the sum of:

- The tractor's empty weight,
- The ballast,
- The total weight of the mounted machine or the vertical load of the hitched machine.

This instruction only applies in Germany:

If the axle loads and/or the total authorised weight are not complied with after all the possibilities have been exhausted, the competent authority according to the law of the Land may issue a waiver based on the report of an approved expert in the field of motor vehicle circulation and with the agreement of the manufacturer, in accordance with article 70 of the German law governing the authorisation of vehicles to use the public highway, and the obligatory authorisation under the German highway code.

Combining of machines: do not combine machines that are incompatible or are incompatible with the tractor when combined.

AGRISEM denies any liability in the event of damage resulting from a combination of machines that has not received written authorisation from AGRISEM.

Accidents linked to the breaking of components during operation may result from unauthorised combinations of hitching equipment.

Hitching and ballasting are operations which involve a risk of injury.

➤ **Before hitching or unhitching:**

- Place the machine on stable ground.
- Chock the machine and take all of the necessary measures to avoid the accidental movement of the tractor.

The machine must only be coupled using the coupling points provided for this purpose and in accordance with the applicable rules.

When hitching, do not exceed:

- The tractor's total authorised weight
- The tractor's authorised axle loads
- The permissible load capacities of the tyres mounted on the tractor.



No one must be standing between the tractor wheels and the tool when hitching or unhitching.

1.3.1.4. Instructions to be followed before using the machine

WARNING

A failure to take movement or operating safety measures may result in accidents involving crushing, cuts, entanglement, pinching or impacts.

Before start-up, check that the machine and the tractor are able to move and operate in complete safety.

Never climb onto the machine or stand on it when it is moving.

Never work in reverse.

Never allow children to climb on the tractor or the machine, or to play near the equipment, even if the machine is stopped.

When using or manoeuvring the machine ensure that no-one is within the manoeuvring or working area.

The elements of the machine that are controlled by an external force have crushing and shearing zones. Keep away from these hazardous areas.

Be aware of hidden obstacles (stones, roots, pipes, cables, etc.) in the event of a collision with an obstacle.



In such an event you must stop the drive, stop the tractor engine, remove the ignition key and wait for the machine to stop completely.

Before starting work again, check the machine for any damage.
If the obstacle is an electric cable or gas pipe, inform the appropriate authorities.

When using the machine, stones or other foreign bodies are likely to be thrown a considerable distance.

Move any people or animals likely to be in the danger area around the machine.

Do not stand in the machine's working area or in the area where the machine rotates and pivots.

Each time the machine is used, carry out a careful visual inspection of the machine to detect any external damage and ensure that the safety and protection devices are operating correctly. Also carry out regular inspections of the various adjustments.



Do not approach the machine until all of the moving parts are completely immobile. Enforce a 50-metre safety area around the machine.

➤ **With regard to driving:**

Adapt your driving to ensure that you are in control of the tractor with the machine mounted or hitched under all circumstances.

Take into account your personal faculties, the conditions of the land or road, the traffic, the visibility and the weather, the tractor's driving characteristics and the conditions of use when the machine is mounted or hitched.

Ensure that the rules of safety and caution dictated by each situation are applied.

The speed and driving style must always be appropriate to the land, roads and tracks.

Reduce your speed on uneven ground or tight corners.

On bends, take into account the overhang and the inertia of the mounted tool.

Avoid sudden changes of direction at all times.

Do not leave the driver's seat until the equipment has completely stopped, the engine is off and the parking brake is on.

Do not transport any people or animals on the machine and the additional tools during work or transport.

➤ **When driving on the public highway:**

Comply with the highway code applicable in your country.



Before going out onto the public highway, check the width of the machine and unbolt or remove elements that exceed the regulatory width.

Take into account the widths authorised for transport and the transported height depending on the hitched machine, in line with current legislation.

Before setting off on the road, ensure that the hitched machine is fitted with the lighting and signalling devices required by the highway code and any other devices required by the current regulations.

AGRISEM rear signalling lights and panels may be removed when working. Check that this signalling equipment has been correctly refitted.

Check that the equipment is clean and operating correctly. Replace all missing or damaged equipment.

Before travelling on the road, secure all of the machine's pivoting parts in their transport position to avoid dangerous changes of position. Also check that the screws, nuts and bolts are tightened and that all of the machine parts are correctly attached and cannot move or become detached.

If your machine is a folding machine, the locking system must be engaged.

Follow the instructions in this manual on how to prepare the machine for transport.

If necessary, also check:

- The connection of the supply pipes;
- The braking system and the hydraulic circuit.

If the equipment does not already have them, fit signalling devices: lighting board, reflectors, reflective plates or adhesive strips.

Ensure that the machine or additional equipment does not hide the tractor's lights.

Ensure that the tractor tyres are inflated to the correct pressure.

Ensure that the tractor and additional equipment is correctly balanced.

Install ballast at the front and back to ensure that the brakes and steering are effective.

The tractor's front axle must systematically support at least 20% of the tractor's empty weight to guarantee sufficient manoeuvrability.

Never drive at more than 25km/hour when under load.

Clean off any soil stuck to the machine before going out onto the road.

After using the public highway, ensure that the road is cleaned of any mud left by the tractor and tools.

The driver/owner has sole responsibility when transporting the machine on the public highway.

1.3.1.5. Instructions to be followed before carrying out any operations on the machine

In particular during cleaning, servicing and repairs.

Comply with the instructions in this manual regarding the servicing of the machine.

Before carrying out any operations on the machine:

- Ensure that the machine is on stable ground.
- **Stop the tractor engine, remove the ignition key, wait for all of the moving parts to stop and engage the hand brake.**
- Set the machine on the ground, depressurise the hydraulic circuit and allow the machine to cool down.
- Secure the machine or elements that are in a raised position to avoid any accidental lowering.
- Chock the machine.

If using a high-pressure washer or steam cleaner, it is essential to comply with the following points:

Do not clean the electrical and hydraulic components.

Never direct the high-pressure washer or steam cleaner nozzle directly at the lubrication points or bearings.

Systematically keep the nozzle a reasonable distance from the machine.

Comply with the rules for using high-pressure washers.

Wear appropriate personal protective equipment for the work to be performed. In particular, wear safety shoes and gloves to handle sharp parts.

Take all of the necessary precautions when fitting working parts that are both heavy and sharp.

The machine must only be serviced and repaired by competent persons who are familiar with the machine's features and operating procedures.

The machine must only be repaired with genuine AGRISEM International spare parts.

For bare metal parts, use either an anti-rust product that leaves a greasy film or thick grease.

According to the type of machine: before carrying out any work on the electrical circuit or before any welding operations, disconnect the wiring harnesses coming from the tractor. Disconnect the battery and alternator cables.

Do not weld or use blow torches near pressurised fluids or inflammable products.

1.3.1.6. Instructions regarding installation

The machine may be fitted with electronic components and elements which may be affected by electromagnetic emissions from other devices. This type of interference may be a source of danger for people if the following safety instructions are not followed:

- If devices and/or electrical components are installed on the machine and connected to the on-board electrical circuit at a later date, the user must first check that installing these components will not interfere with the vehicle's electronics or other components.
- Ensure that electrical and electronic components subsequently installed comply with the current version of electromagnetic compatibility directive 2004/108/CEE and that they have a CE marking.

Before carrying out any operations on the electrical system, disconnect the battery's negative terminal.

Only use the recommended fuses. Using fuses which have too high an amperage may damage the electrical system and create a risk of fire.

Ensure that the battery terminals are correctly connected, starting with the positive terminal and then the negative terminal. When disconnecting the terminals, start with the negative terminal and then disconnect the positive terminal.

Systematically fit the cover provided for this purpose on the battery's positive terminal. Be aware of the risk of explosion when earthing.

Risk of explosion: avoid sparks and naked flames near the battery.

1.3.1.7. Instructions regarding the hydraulic system

If your machine is fitted with a hydraulic circuit, you must comply with the following instructions:
Warning! The hydraulic circuit is pressurised.

When mounting cylinders and hydraulic devices, take particular care to ensure that the circuits are correctly connected, in accordance with the manufacturer's instructions.

Mark the sockets and connectors of the hydraulic connections between the tractor and the machine to avoid handling errors.

Before connecting a hose to the tractor's hydraulic circuit, ensure that the circuits on both the tractor side and the machine side are perfectly clean and not under pressure.

Before connecting, check that the hydraulic quick connectors on the machine and the tractor are free from impurities.

Before performing any operations on the hydraulic circuit, lower the machine, depressurise the circuit, switch off the tractor engine, engage the parking brake and remove the ignition key.

Before carrying out any operations, allow the machine to cool down and discharge the hydraulic circuits' accumulators.

Check the hydraulic hoses regularly. Damaged or worn hoses must be replaced immediately. Check the appearance of the hydraulic hoses to detect any signs of tears or abnormal wear.

When replacing hydraulic hoses, ensure that you only use hoses of the characteristics and quality recommended by the machine's manufacturer.

Each time the machine is used, the hydraulic quick connectors' end fittings must be cleaned and the protective caps must be fitted afterwards. Replace connectors which do not lock correctly or which leak.

Hydraulic hoses must never trail on the ground.

If you find a leak, take all of the necessary precautions to avoid accidents. Never try to plug the leak with your hand or fingers.

**Any pressurised liquid, in particular oil in the hydraulic circuit, can penetrate the skin and cause serious injury and infections.
In the event of injury, consult a doctor immediately.**

To avoid accidents caused by unexpected hydraulic movements or by third parties, the distributors on the tractor must be locked or immobilised when they are not being used or in their transport position.

1.3.1.8. Instructions relating to the braking system

The braking system must be checked and serviced regularly. Servicing and repair work and adjustments must only be carried out by brake system specialists.

Stop the tractor immediately in the event of a brake system malfunction and have it repaired.

Before performing any operations on the braking system, place the machine on stable ground and chock it.

After any adjustment or repair work on the braking system, perform a braking test.

1.3.1.9. Instructions specific to AGRISEM seeders

In addition to the instructions applicable to all of machines, AGRISEM seeder users must comply with the following instructions:

**Never climb onto the machine elsewhere than on the AGRISEM walkway provided for this purpose.
Only climb onto the machine when it is stopped.**

When operations are performed on the AGRISEM seeder or during flow tests, the seeder must be stationary and a 50-metre safety area must be enforced around it. The hydraulic system must be depressurised (e.g. turbine stopped) and the rear window of the tractor must be shut, the tractor switched off and the ignition keys removed.

Ensure that no one is on or near the seeder when the grain is being loaded. The AGRISEM walkway must only be used when the seeder is stationary.

Always ensure that the entire area within the seeder's dimensions is completely clear.

Never stand under the sun wheel when it is in its transport position.

When testing the distribution flow, the user must turn the sun wheel with care to avoid any injury. When the wheel is rotating, no-one must be within 50 metres of the machine. This means that no-one must put their fingers into the distribution grooves unless the transmission system is completely stopped.

When changing the transmission gear ratios, ensure that the gearing and chain are handled with the greatest care to avoid any injury. No-one must be within 50 metres of the machine. Avoid putting yourself in danger when changing the gearing by avoiding climbing on the machine's beams or disks, as this could be dangerous.

Ensure that the sun wheel is protected during transport to avoid it hitting anything or injuring anyone.

Similarly, when the turbine is started up, a safety area must be enforced around the machine due to the risk of objects or liquids being ejected (e.g. soil, oil, stones, metal, etc.).

When travelling on the public highway, always be very careful and alert. As the rear visibility is reduced during transport, ensure that the way is clear before reversing the machine (50-metre safety area).

The user must comply with the highway regulations applicable in his country with regard to the front hopper.

If the tractor's signalling equipment is not sufficient (or not sufficiently visible) ensure that you fit your front hopper with lighting and signalling plates.



When working, a 50-metre safety area must be enforced due to the risk of objects being ejected.

1.3.1.10. Instructions relating to safety systems with spring assemblies

Safety devices with pre-compressed spring assemblies are fitted on many AGRISEM tools. These can be very dangerous when performing technical operations on the machine if all of the necessary precautions are not taken.

WARNING: Written authorisation must be obtained from AGRISEM International before carrying out any operations on the "Spring Assembly".

1.3.1.11. Instructions relating to transmission shafts with universal joints

Consult the tractor manufacturer's instructions when performing any operations on transmission shafts with universal joints.

1.3.1.12. Instructions relating to loading and transport

Unless there is a specific transport agreement:

- For deliveries of less than three tonnes: the carrier is responsible for the loading, chocking, securing and unloading of the equipment from when he takes charge of it until its delivery.
- For deliveries of more than three tonnes: loading, chocking and securing on the one hand, and unloading on the other hand, are the responsibility of the contracting party or the recipient respectively. The responsibility for any equipment damage that occurs during these operations lies with the person carrying them out.

Unless there is a specific transport agreement, and for deliveries of more than 3 tonnes, the Purchaser will therefore unload the machine under his own responsibility.

Similarly, if the Purchaser sells the machine and has it delivered, as the sender, he will be responsible for the loading, chocking and securing of the equipment when it is sent.

In case of doubt regarding the unloading or loading, chocking and securing of the machine, please contact AGRISEM International.

1.3.1.13. The user's workstation

The machine must be operated by one person only, from the tractor driver's seat.

1.3.1.14. Noise data

The sound pressure level is 77 dB(A), as measured at the level of the user's ear during operation with the cab closed.

The sound pressure level mainly depends on the tractor used.

Measuring device: NICETY SL801A.

1.3.2. Safety symbols on the machine

ETIQ-501

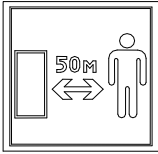

Keep a safe distance from the machine during work. Risk of serious injury.
Ensure that no-one is in the danger zone around the machine when the tractor engine is running.

ETIQ-502

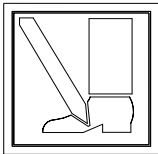

Keep a safe distance from the machine when lowering it. Risk of serious injury.
Ensure that no-one is under the machine when lowering it.

ETIQ-503

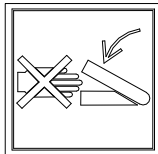

Beware of pinching. Risk of serious injury.
Do not touch the hazardous areas under any circumstances while the tractor engine is running and the universal joint shaft, hydraulic circuit or electronic system is operating.

ETIQ-504

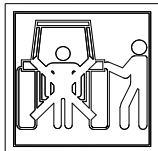

Keep a safe distance from the rear of the tractor during manoeuvres. Risk of serious injury.

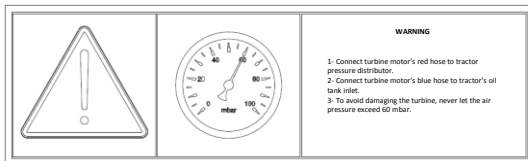

Warning: never exceed a maximum air pressure of 60 mbar as this may damage the turbine.

ETIQ-908

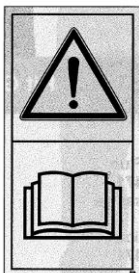

Read the maintenance book and safety instructions before starting up the machine and abide by them during operation.

2. TECHNICAL INSTRUCTIONS

2.1. SETTINGS AND USE



FOREWORD:

As far as possible, read this chapter while standing in front of the machine.

When you receive the MAXIMULCH, check that its characteristics are appropriate. Then carry out all of the preliminary operations prior to start-up as described in this manual.

2.1.1. Technical characteristics

=> MAXIMULCH Series 3 FIXED

	Fixed models		
Working width (in metres)	3.00	3.50	4.00
Tractor power minimum	88 kW 120 hp	107 kW 145 hp	125 kW 170 hp
Tractor power maximum	118 kW 160 hp	143 kW 195 hp	162 kW 220 hp
Weight (variable depending on the equipment)	2,542 kg	2,903 kg	3,284 kg
Hitch type	Category 3 hitch		

=> MAXIMULCH Series 3 FOLDING

	Folding versions	
Working width (in metres)	4.50	6.00
Tractor power minimum	130 kW 180 hp	184 kW 250 hp
Tractor power maximum	184 kW 250 hp	257 kW 350 hp
Weight (variable depending on the equipment)	8,415 kg	10,280 kg
Hitch type	Category 3 hitch	

=> MAXIMULCH Series 6 FOLDING

Working width (in metres)	Folding versions		
	4.00	5.00	6.00
Tractor power minimum	147 kW 200 hp	206 kW 280 hp	257 kW 350
Tractor power maximum	221 kW 300 hp	294 kW 400 hp	331 kW 450
Weight (variable depending on the equipment)	8,275 kg	9,365 kg	10,450 kg
Hitch type	Category 3 hitch		

2.1.2. Hitching and unhitching the Maximulch



It is ESSENTIAL to read the safety instructions before reading the practical instructions for hitching and unhitching the machines



No-one must be within 50 metres of the machine while it is being hitched or unhitched

Before hitching or unhitching the MAXIMULCH, it is important to ensure that:

- The tool is or will be on stable ground and no-one is within 50 metres of the machine.
- The top-links of the tractor's three point hitch are adjusted to the same dimensions
- The tractor tyres are inflated to the same pressure
- The tractor is suitable for the tool to be hitched and is weighted appropriately
- The tractor connections are suited to the tool to be hitched.

- When hitching, do not exceed:
 - The tractor's total authorised weight
 - The permissible load capacities of the tyres mounted on the tractor.
 - The tractor's authorised axle loads



Check that the tractor meets the necessary requirements before hitching the machine:

- Total authorised weight
- Permissible load capacities of the tyres



The authorised values for the total weight, the axle loads and the tyre load capacities can be found in the tractor's registration papers.

2.1.2.1. Tractor-mounted machine

➤ **Hitching a tractor-mounted machine:**

- 1/ Ensure that the machine is on stable ground
- 2/ Bring the tractor up to the coupling on the machine.
- 3/ Place the lower link arms in line with the drawbar couplings.
- 4/ Hitch the lower link arms using the appropriate equipment.
- 5/ Adjust the length of the top link and attach it using the pin and clip provided.
- 6/ Lock all of the hitch pins with lock handles using the clip pins.
- 7/ Connect the hydraulic hoses if the machine is fitted them.
- 8/ Connect the plug for the lighting equipment and check that it is operating.
- 9/ Lift the machine.
- 10/ Lock the machine for transport if it folds using the hydraulic controlled hook or mechanical locks.
- 11/ Ensure that everything is correctly connected and locked and that there are no foreign bodies on the machine.

➤ **Point of convergence:**

The point of convergence can be adjusted to improve the tractor's traction, stability and grip. This also affects the tractor's lifting capacity.

On a tractor with 2 drive wheels, the point of convergence must be near to the centre of the tractor.



On a tractor with 4 drive wheels, the point of convergence must be towards the front drive axle.

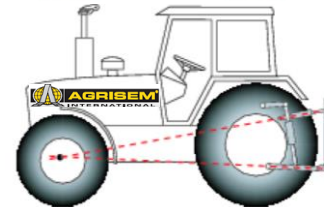

➤ **Parking:**

- 1/ Ensure that the machine is unhitched on stable ground.
- 2/ Unlock the machine before unfolding it
- 3/ Unfold the machine if it folds.
- 4/ Disconnect the hydraulic hoses if the machine is fitted with them.
- 5/ Disconnect the plug for the lighting equipment.
- 6/ Unhitch the machine.

2.1.2.2. Trailed machine

➤ **Hitching a trailed machine:**

- 1/ Place and chock the machine on stable ground.
- 2/ Close the hydraulic circuit using the valves.
- 3/ Back up the tractor until it is 30cm away.

- 4/ Connect the drawbar cylinder's hoses.
- 5/ Lift the ring above the level of the tractor's hitch.
- 6/ Hitch the tractor to the MAXIMULCH.
- 7/ Retract the parking stands if the machine is fitted with them.
- 8/ Connect the braking system
- 9/ Connect the lighting system
- 10/ Connect the other folding and locking hoses if the machine folds.
- 11/ Perform a braking test after hitching (if the machine has brakes).
- 12/ Ensure that everything is correctly connected and locked and that there are no foreign bodies on the machine.



Take into account the clearance during transport, in particular to ensure that there is room to pass under bridges and low power lines (e.g. MAXIMULCH 6.5M)



On tractor-mounted machines, the drawbar must be hitched to the top holes on the lower arms. This improves the stability of the machine when working.

➤ **Parking:**

- 1/ Ensure that the machine is unhitched on stable ground.
- 2/ Unlock the machine before unfolding it.
- 3/ Unfold the machine if it folds.
- 4/ Lower the machine with the drawbar and the trailed or semi-mounted kit.
- 5/ Disconnect the hydraulic hoses if the machine is fitted with them. If you are using a towing hook, disconnect the hydraulic hoses last to be able to adjust the height of the drawbar.
- 6/ Disconnect the plug for the lighting equipment.
- 7/ Unhitch the machine.

2.1.3. Folding - Unfolding

If you have a folding Maximulch, take care when folding or unfolding. Refer to the relevant section.



It is ESSENTIAL to read the safety instructions before reading the practical instructions for hitching and unhitching the machines



Before folding or unfolding check that there are no foreign bodies that could hinder movement



No-one must be within 50 metres of the machine while it is being folded or unfolded

a- Folding the extensions

Follow the procedure below to fold your Maximulch:

- Place the folding extensions' roller arms in the highest MULTISTOP position (e.g. 15). This allows the rollers to be retracted within the machine as much as possible in their transport position (see section on adjusting the roller's height). The rollers must therefore remain within the regulatory width (width of less than 2.98m during transport).

- Fold the machine
- The hydraulic locking kits will be engaged otherwise put the mechanical locking kit in place (depending on the model)

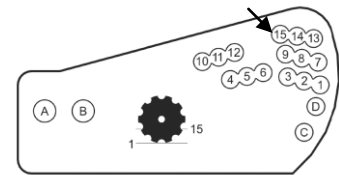

MULTISTOP

b- Unfolding the extensions

Follow the procedure below to unfold your Maximulch:

- Place the roller arms in the MULTISTOP position required for working
- Actuate the hydraulic locking hoses by pressurising them or remove the mechanical locking kit (depending on the model)
- Actuate the hydraulic unfolding hoses by pressurising them until the extensions arrive at the mechanical stop. The hoses must be operated with care.

Some MAXIMULCH series 3 machines have hydraulic unfolding and folding.
To do this, the following procedure must be followed:

c- Folding the roller

1. Fold the roller using the tractor's hydraulic distributor
2. Close the safety valve under the MAXIMULCH's coupler head



d- Unfolding the roller

1. Open the safety valve under the MAXIMULCH's coupler head
2. Unfold the roller using the tractor's hydraulic distributor
3. Leave the tractor's hydraulic distributor pressurised during field use



There must be nobody within 50 metres of the machine when you are folding or unfolding the MAXIMULCH's roller.



Never put the MAXIMULCH in the earth if the roller is not unfolded

2.1.4. Starting up the MOUNTED MAXIMULCH



The tool's tilt during work is adjusted by adjusting the top link "A".
The AGRISEM Multistop allows you to adjust the working depth using the roller.

2.1.4.1 Adjusting the working depth:

Adjustment: CHANGING THE ROLLER'S POSITION

Changing the roller's position to increase the working depth:

1. Raise the machine into "Transport" position to release the roller arms' pressure on the multistop upper stop pins.
2. Place the multistop upper stop pins in a **higher** position. (e.g. if the pins are in position 4, the pin must be put in position 5).

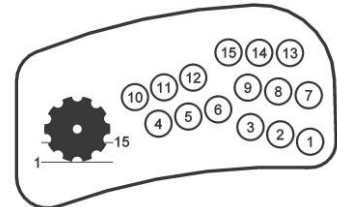

Changing the roller's position to decrease the working depth:

1. Raise the machine into "Transport" position to release the roller arms' pressure on the multistop upper stop pins.
2. Place the multistop upper stop pins in a **lower** position. (e.g. if the pins are in position 5, the pin must be put in position 4).

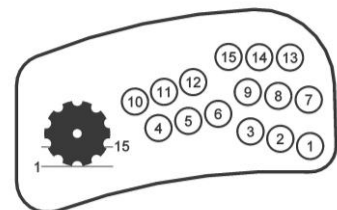

RECOMMENDATION: If this is permitted by the working position, immobilise the roller arms using the lower stop pins. This prevents friction between the roller arms and the multistops that might otherwise cause premature wear.

2.1.4.2. Mechanical adjustment of the depth of the spring safety blades

The working depth of the blades can be adjusted manually without affecting the working depth of the disks.

Each of the blades must be adjusted in the same way.

The following procedure must be followed:

1. Check that the beta clip is present to prevent the blade falling when it is adjusted (see photo 1).



Never remove the pin if the clip is missing.

2. Remove the pin. (see photo 2)
3. Using a wrench, slide the blade to the required height. (see photo 3)
4. Replace the pin and the clip. (see photo 2)

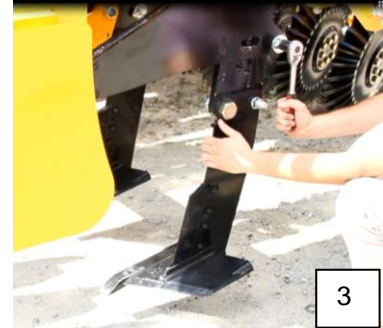

The MAXIMULCH can be used without the blades by simply removing the blades.

To remove the blades, follow the procedure described above, lowering the blades as far as possible so that they come out of their rack and pinion housings.

Check that the tool is correctly hitched and is perfectly horizontal during work, sideways and crossways.



Turn off the tractor's engine and put on the handbrake before performing any work on the MAXIMULCH.



At the end of the field, the MAXIMULCH must be lifted to avoid subjecting the tool to crossways movements before turning around. The tractor should therefore be aligned with the direction of work before the MAXIMULCH is lowered.

2.1.4.3. Mechanical adjustment of the depth of the bolt safety blades

The working depth of the blades can be adjusted manually without affecting the working depth of the disks.

Each of the blades must be adjusted in the same way.

There are 6 different positions between the minimum and maximum height.

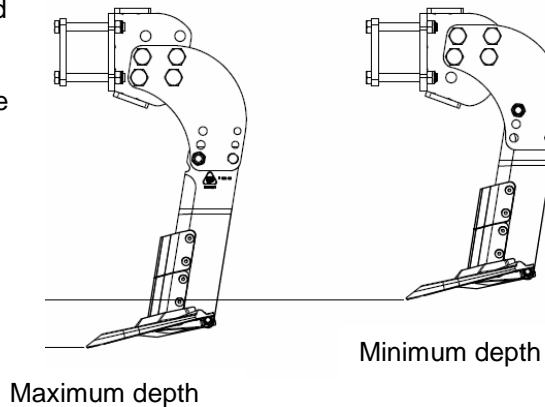

2.1.5. Starting up the TRAILED MAXIMULCH

To adjust the working depth on a folding MAXIMULCH, there are two main adjustments:

1st adjustment: CHANGING THE ROLLER'S POSITION

Changing the roller's position to increase the working depth:

1. Raise the machine into "Transport" position to release the roller arms' pressure on the multistop upper stop pins.
2. Place the multistop upper stop pins in a **higher** position. (e.g. if the pins are in position 4, the pin must be put in position 5).

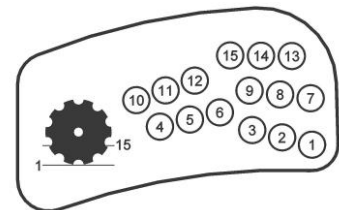

Changing the roller's position to decrease the working depth:

1. Raise the machine into "Transport" position to release the roller arms' pressure on the multistop upper stop pins.
2. Place the multistop upper stop pins in a **lower** position. (e.g. if the pins are in position 5, the pin must be put in position 4).



RECOMMENDATION: If this is permitted by the working position, immobilise the roller arms using the lower stop pins. This prevents friction between the roller arms and the multistops that might otherwise cause premature wear.

2nd adjustment: CHANGING THE NUMBER OF SHIMS ON THE CYLINDER*

The working depth of the MAXIMULCH can also be adjusted using the shims on the drawbar cylinder. This involves adding more or fewer shims.

By increasing the number of shims you reduce the working depth.

By decreasing the number of shims you increase the working depth.

*In the case of a drawbar with a ball hitch and push bar, the adjustment is done by lifting the tractor. The push bar is then put in the intermediate position.



Hydraulic adjustment of blade depth

The working depth of the blades can be adjusted hydraulically without affecting the working depth of the disks.

Each of the blades must be adjusted in the same way.

The following procedure must be followed:

1. Release the pressure on the pins by raising the blades slightly using the tractor's distributor.
2. Remove the set pins. (see photo 2)
3. Using the dual-effect distributor, adjust the blades to the required height. (see photo 3)
4. Replace the pins, rings and clips. (see photo 4)



It is vital that the rings are placed at the end of the set pin. Never put the MAXIMULCH into the earth if these rings are missing.

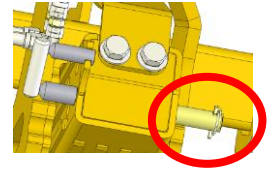

5. Lower the blades to lock the pins.



There must be nobody within 50 metres of the machine when you are adjusting the height of the MAXIMULCH blades.

As well as hydraulic adjustment, the folding MAXIMULCH also has 2 further adjustments on the blade holder where the spring safety is attached. This adjustment is also available on bolt safety versions

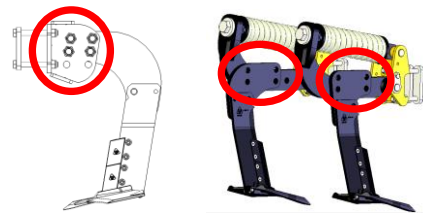

Bolt safety

Spring safety

The MAXIMULCH can be used without the blades by simply folding the blades forward. To fold the blades forward, just remove the safety bolt from each of the blades and attach it to the central hole at the bottom of the holder.

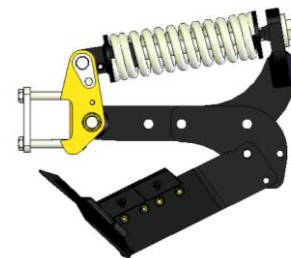
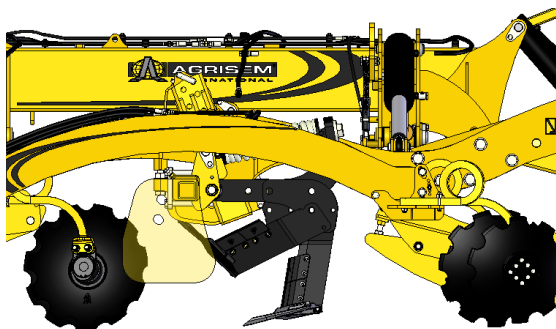

Adjusting the border spreading disk

1. Loosen the 3 screws
2. Adjust the tilt of the border spreading disk using the slotted holes
3. Retighten the screws



Adjusting the LH side deflector

1. Loosen the screws and the lock nuts
2. Adjust the deflector to the required position
3. Retighten the screws and the lock nuts

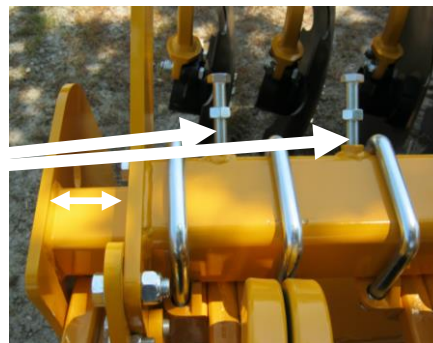

Adjusting the RH side deflector

The right-hand side deflector is designed to limit the spraying of soil from the second row of disks. The deflector must not be in contact with the ground during use. This requires some adjustments:

- Clearance adjustment: The space between the last disk and the deflector may be adjusted (see figure 2)
- Vertical adjustment: The space between the ground and the deflector may be adjusted using the stop screw "B" (see figure 1)

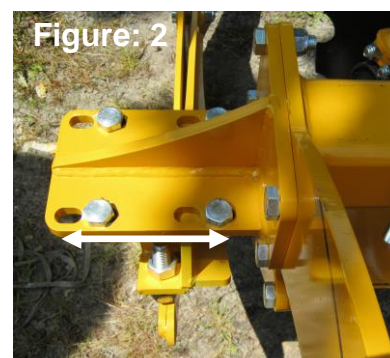
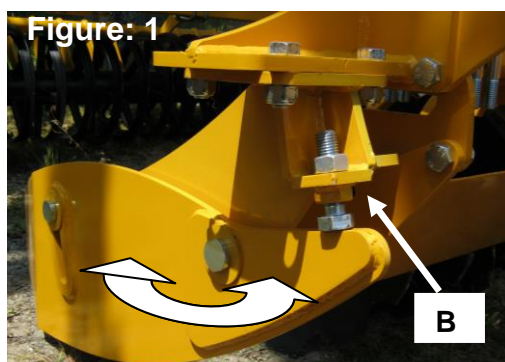

2.1.6. Starting up the MAXIMULCH Series 6

The working depth of the MAXIMULCH teeth can be adjusted using the shims on the drawbar cylinder and the roller cylinder. This involves adding more or fewer shims. By increasing the number of shims you reduce the working depth. By decreasing the number of shims you increase the working depth.

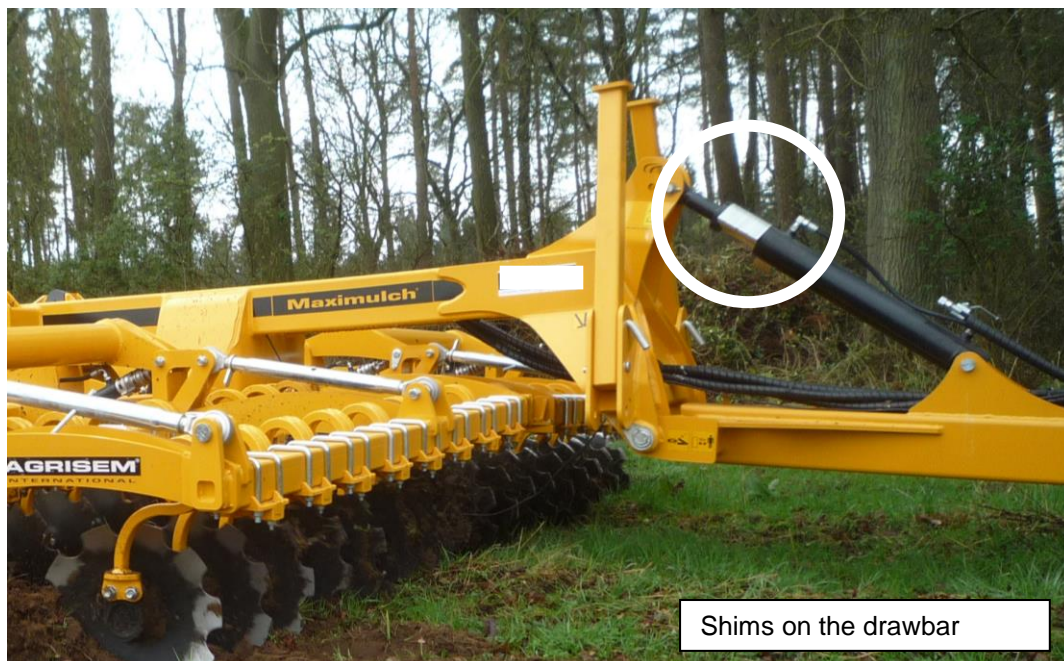

The tilt of the front disks is adjusted using the push bars.
All of the push bars must be adjusted to the same length.
This adjustment may vary depending on the type of earth, the amount of plant residue and the wear of the disks.

The working depth of the front disks is adjusted using the shims on the cylinder.



The working depth of the levelling disks is adjusted using the shims on the cylinder.
A shim holder is available for unused shims.









Adjustment must be the same across the whole tool width.
The machine must work horizontally in relation to the ground and be true.

2.1.7. Recommendations for use:

1. Before use, check that all of the safety instructions have been followed and that lubrication and maintenance have been correctly performed.
2. To achieve good results, the soil should be neither too damp nor too dry.
3. If the soil is too damp, the soil's surface structure risks being damaged by wheel spin. A four-wheel drive tractor should be used to reduce wheel spin.
4. Check the following list before starting work.
 - Are the wear parts in good condition and correctly mounted?
 - Does the front of the tractor have enough ballast to lift the tool?
5. During use, check that the tool is correctly hitched and is perfectly horizontal during work, sideways and crossways.
6. Where necessary, consult your tractor's user manual to familiarise yourself with the tractor hitch safety and adjustment instructions for optimum use of the equipment.
7. Proper use of the tool ensures optimum, safe crop planting. If the soil's quality deteriorates and the required result is not achieved, AGRISEM INTERNATIONAL cannot be held liable under any circumstances. It is up to the user to decide on and take full responsibility for the risks linked to the improper or inappropriate use of the tool.
8. Never work in reverse.

The disks:

The disks must be replaced as soon as their diameters reach the values given below.

Serrated disk diameter	Max. wear diameter	Mulcher disk diameter	Max. wear diameter
 Ø 610	Ø 520	 Ø 510	Ø 430
 Ø 510	Ø 440	 Ø 560	Ø 430
 Ø 560	Ø 480	 Ø 610	Ø 430

AGRISEM INTERNATIONAL cannot be held liable if the MAXIMULCH is used with disks presenting greater wear than that specified above.

2.1.8. Operating recommendations:

Problems	Point to be checked	Solutions
The MAXIMULCH will not go into the earth	Wear on the shares	Replace the shares
The MAXIMULCH is not working at the same depth on the right and the left	The tractor's top-links	The tractor's top-links must be adjusted to the same length
Irregular working depth	Adjustment of the extensions	Adjust the settings of the extension stops

2.2. SERVICING - MAINTENANCE

Comply with the safety instructions regarding servicing and maintenance. Your machine has been designed and built for maximum yield, profitability and comfort under many different usage conditions. Your machine has been checked at the factory and by your dealer before its delivery to ensure that you receive a machine in perfect condition. To maintain it in good working condition, it is important that servicing and maintenance operations are performed at the recommended frequency.

In order to ensure that your machine always operates correctly and to obtain an optimum performance, you must clean and maintain it at regular intervals. The hydraulic components and bearings must not be cleaned with a high-pressure washer or directly hosed down. The units, screwed connectors and bearings are not watertight to VERY high pressure cleaning.

2.2.1. Servicing frequency

The servicing frequency is determined by various factors. Different usage conditions, the weather, driving and working speeds, dust and the type of soil, etc. affect the frequency, and the lubrication and maintenance products used also determine the time until the next servicing work is required.

The servicing frequency indicated is therefore only to be used as a reference. If you deviate from the normal conditions of use, you must adapt the frequency at which this maintenance and servicing is carried out to suit the conditions:

1/ After the first 10 hours of use:

- Check the tightness of the nuts and screws
- Check the hydraulic system (tightness and sealing)
- Check the tightness of the wheels
- Perform a complete diagnosis of the machine to ensure that there are no elements causing problems.
- Clean the soil off the machine

2/ Every 50 hours of use

- Check the tightness of the nuts and screws
- Check the hydraulic system (tightness and sealing)
- Check the tightness of the wheels
- Perform a complete diagnosis of the machine to ensure that there are no elements causing problems.
- Lubricate the joints with greasers
- Clean the soil off the machine

2.2.2. Storage

If the machine is not going to be used for an extended period:

- Store the machine under a roof if possible.
- Disconnect electrical control devices and store them in a dry place.
- Protect the machine against rust. Only spray with oils that are easily biodegradable, e.g. rape oil.
- Unload the wheels.
- Protect the hydraulic cylinder piston rods against corrosion.

Do not spray plastic and rubber parts with oil or an anti-corrosion agent or these parts may become fragile and break.

2.2.3. Lubrication

Lubricating the machine:

The machine must be lubricated regularly and after each pressure wash.

This keeps the machine in good working order and reduces the costs of repairs and downtime.

Hygiene:

Using lubricants and mineral products in line with the recommendations does not present any health risks. However, avoid prolonged contact with the skin or inhaling the vapours.

Handling lubricants

WARNING:

Protect yourself from direct contact with oils by wearing gloves or protective cream.

Carefully wash all traces of oil off your skin with soap and hot water. Do not clean your skin with petrol, diesel or other detergent products.

Oil is toxic. If you swallow oil, consult a doctor immediately.

- Keep lubricants out of reach of children.

- Never store lubricants in open containers or containers that are not labelled.
- Avoid your skin coming into contact with clothes that are soaked in oil. Change clothes when they are dirty.
- Do not keep cleaning cloths impregnated with oil in your pockets.
- Dispose of shoes impregnated with oil as dangerous waste.
- If oil splashes in your eyes, rinse with clean water and consult a doctor.
- Soak up spilt oil with a binder product and dispose of it.
- Never extinguish fires caused by oil with water. Only use authorised, appropriate extinguishing products and wear breathing apparatus.
- Waste polluted by oil and used oil must be disposed of in line with current regulations.

Lubricate / grease the machine at the stated frequency.

Carefully clean the lubrication points and the grease pump before lubrication to avoid any dirt getting into the bearings. Drain contaminated grease out of the bearings and replace with new grease!

2.2.4. Maintenance

- Hydraulic maintenance

Risk of infection caused by the oil in the hydraulic circuit penetrating the skin under high pressure.

- Operations on the hydraulic circuit must only be performed by a specialised workshop.
- Depressurise the hydraulic circuit completely before carrying out any operations on it.
- Only use appropriate tools to look for leaks.
- Under no circumstances must you try to plug a leak in the hydraulic hoses with your hand or fingers.
- Liquid leaking under high pressure (hydraulic oil) can penetrate the skin and cause serious injury.
- In the event of an injury caused by hydraulic oil, consult a doctor immediately. Risk of infection.
- When connecting hydraulic hoses to the tractor's hydraulic circuit, ensure that the hydraulic circuits on the tractor and machine are not under pressure.
- Check that the hydraulic hoses are correctly connected.
- Regularly check that the hydraulic hoses and connections are in good condition and are clean.
- Have the hydraulic hoses checked by a specialist at least once a year to ensure that they are in good condition.
- Replace damaged or worn hydraulic hoses.
- Only use genuine AGRISEM hydraulic hoses.
- Hydraulic hoses must not be used for more than six years, including a possible storage time of two years maximum. Even under appropriate storage and usage conditions in line with permissible stresses, it is completely normal for hoses and connectors to age, which is why they have a limited storage time and service life. Nevertheless, the duration of use can be established in line with empirical values, in particular taking potential risks into account. Other reference values can be taken into consideration for thermoplastic hoses and pipes.
- Dispose of used oil in accordance with current regulations. If this poses a problem, contact your oil supplier.
- Keep hydraulic oil out of reach of children.
- Ensure that you do not contaminate the soil or water with hydraulic oil.

After 10 hours of service, and then every 50 hours of service

1. Check that all of the hydraulic circuit's components are sealed.
2. If necessary, tighten screwed connectors.

Before each start-up

1. Visually check the hydraulic hoses for faults.
2. Remove any friction points on hydraulic hoses and tubes.
3. Replace damaged or worn hydraulic hoses immediately.

Inspection criteria for hydraulic hoses.

For your own safety, comply with the following inspection criteria.

Replace the hydraulic hoses if you notice any of the following when examining them:

- Deterioration of the outer layer down to the lining (e.g. friction points, cuts, splits).
- Embrittlement of the outer layer (formation of cracks on the outer layer).
- Distortions which do not correspond to the natural shape of the hose or pipe, whether or not they are under pressure or bent (e.g. separation of the layers, bulges, crushed areas, bending).
- Areas that are leaking.
- Damaging or distortion of the end fitting (affecting its leaktightness). Slight superficial damage does not warrant replacement.
- Hose becoming detached from the end fitting.
- Corroded end fitting leading to reduced solidity and function.
- Non-compliance with mounting specifications.
- Exceeding of the 6-year usage period. The following information is vital: the date of manufacture of the hydraulic hose marked on the end fitting, to which you must add 6 years. If the date of manufacture indicated on the connector is "2004" the usage period will end in February 2010. See the "Marking of hydraulic hoses" section for further information.

Fitting and removing hydraulic hoses

When fitting and removing hydraulic hoses, the following instructions must be strictly adhered to:

- Only use genuine AGRISEM hydraulic hoses.
- Pay particular attention to cleanliness.
- You should always fit hydraulic hoses so that in all operating conditions,
 - ✓ They are not subject to traction, apart from that caused by their own weight.
 - ✓ No short lengths are flattened.
 - ✓ There are no external mechanical stresses on the hydraulic hoses.
 - ✓ Avoid hoses rubbing against parts of the machine or against each other by arranging and attaching them correctly. Protect hydraulic hoses with protective sheaths if necessary. Cover parts with sharp edges.
 - ✓ The authorised bending radii must not be exceeded.
- If hydraulic hoses are connected to moving parts, measure the length of the hose to ensure that the total range of movement is no less than the smallest authorised bending radius and/or that the hose is not subject to traction.
- Attach hydraulic hoses at the places intended for this purpose. Avoid mountings that may hinder the natural movement of the hose and modifications to its length.
- Hydraulic hoses must not be painted.

Wear ring maintenance:

Some joints on AGRISEM tools have wear rings. These must be changed at the first sign of lateral play.

WARNING: Written authorisation must be obtained from AGRISEM International before carrying out any operations on the "Spring Assembly".

Tyre maintenance:

The tyres must always be inflated to a pressure appropriate to their use. The pressure may need to be changed when moving between the road and the field. The average pressure of all Flexi-Pack tyres is 2.5 bars.

2.2.5. Lighting system

Always check that your lighting system is in full working order, clean and operational before driving on the road.



Never set out on the public highway if one of these elements is not in good condition.

Replacing bulbs:

1. Disconnect the lighting board
2. Unscrew the protective glass.
3. Remove the faulty bulb.
4. Fit the replacement bulb (ensure that the voltage and amperage are correct).
5. Refit the protective glass and screw on.

3.3.6. Wear part with carbide plates:

Wear parts with carbide plates are designed for working in fields without stones.

Using them on stony ground may lead to the premature wearing of these parts and possible breaking. It is up to the user to decide on and take full responsibility for the risks linked to the use of wear parts fitted with carbide plates under these conditions.

AGRISEM INTERNATIONAL cannot be held liable under any circumstances for the premature wearing or breaking of wear parts with carbide plates if these instructions are not complied with.

Using the MAXIMULCH correctly ensures that work on crops takes place safely under optimum conditions. It is up to the user to decide on and take full responsibility for the risks linked to the incorrect or inappropriate use of the MAXIMULCH.

AGRISEM INTERNATIONAL cannot be held liable under any circumstances for soil damage or a result that does not meet the user's expectations if the use and safety instructions have not been complied with.



AGRISEM[®]

INTERNATIONAL

WARRANTY CLAIM FORM N°

Dealer's stamp

Dealer's name :

File followed by :

Date of purchase of the machine :

N° Invoice AGRISEM

Customer's name and address :

Delivery date : (join a copy of invoice and dealer's delivery note)

Area of farm :

Serial Number of the machine :

Working width :

Description of the equipment combination (make and type):

Type of tractor used :

Horse Power :

Model of tractor :

Detailed description and presumed causes of incident :

Date of problem :

Date present :

Reference of Defective part

Quantity

Désignation

Price List

Coef SAV

TOTAL (€)

Pictures attached :

YES

Parts returned :

Freight costs paid by the sender

YES

The warranty is limited to replacement of defective parts: excluding reparation of all other damage

RESULT OF AGRISEM INTERNATIONAL EVALUATION

Comments :

Date :

The after-sales service technician

yoann.jaunasse@agrisem.com

Signature :

